

05 / 2017

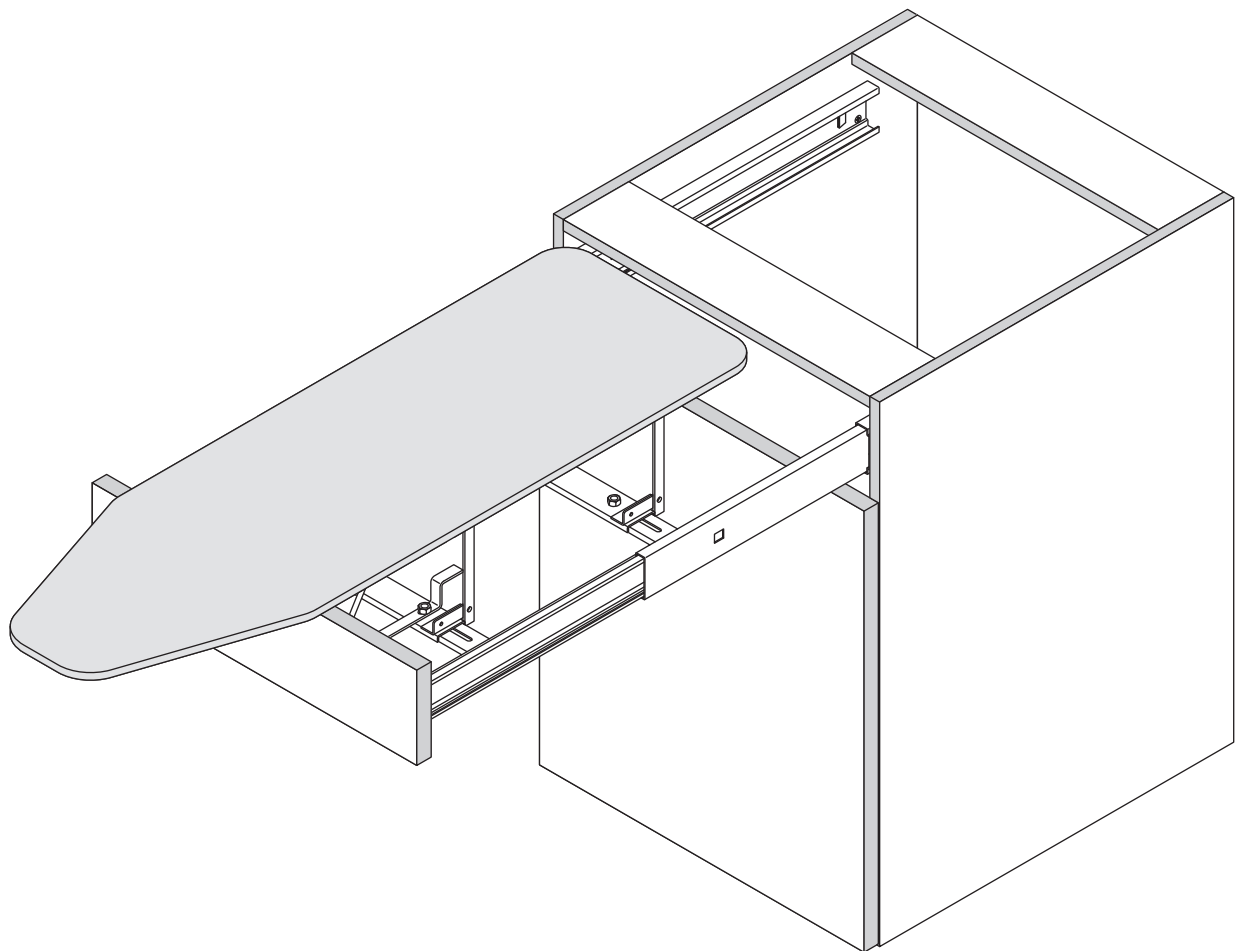

VS ADD Iron

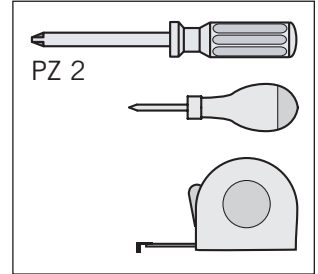
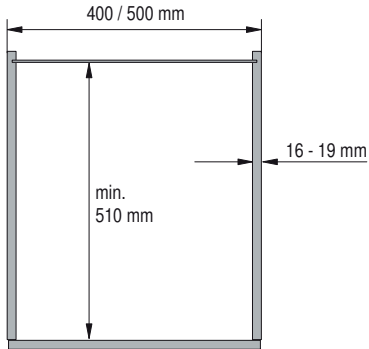

1 Assembling the cabinet guide slide "left / right"

The guide slides are to be positioned in such a way that there are 34 mm between the cabinet front edge and the middle hole of the slide; and from the cabinet upper edge to the middle hole of the slides, there should be 74 mm with a work area stength of 30 mm (work plate area 40 mm = 64 mm) (see diagram A).

Fasteners:

countersunk screws 4.5 x 15
or Euro-screws 6.3 x 13

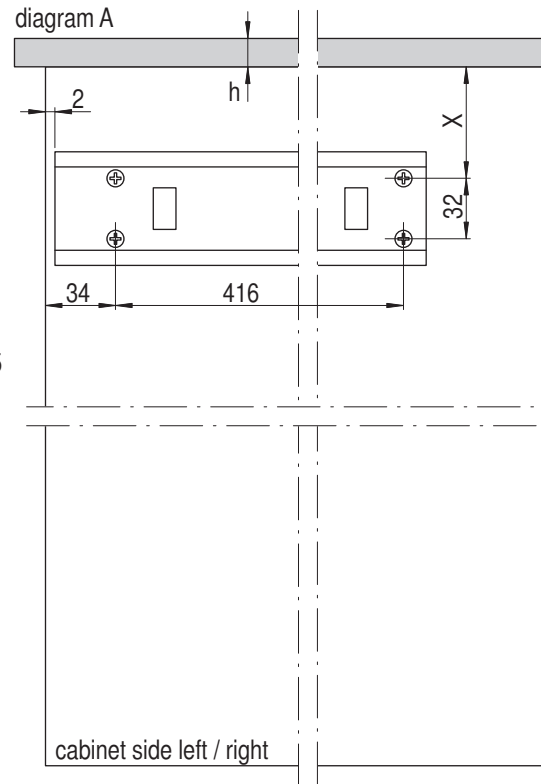
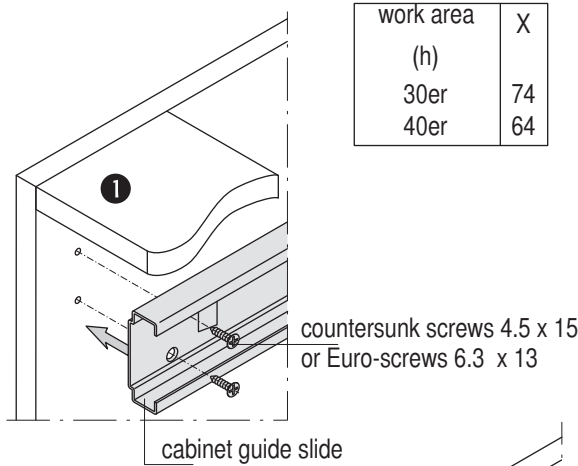

2 Assembling guide slide "left / right"

Push the guide with the support bracket across the mounted cabinet slide.

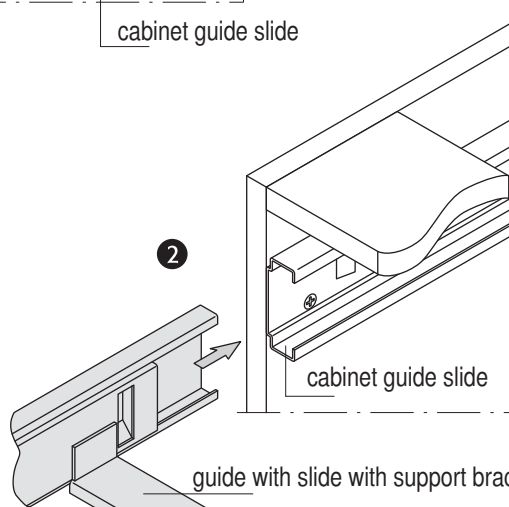

3 Assembling Ironing Board on the Support Bracket

The board is placed in the middle of the support bracket. Place the angle support on the front support bracket. Screw the Ironing board and the angle support bracket from underneath on the support bracket in the front and back.

Fasteners:

Cylinder head screws M 6.0
Washers
Screw nut M 6.0

Note:

Make sure the slide movement is smooth before firmly tightening all screws.

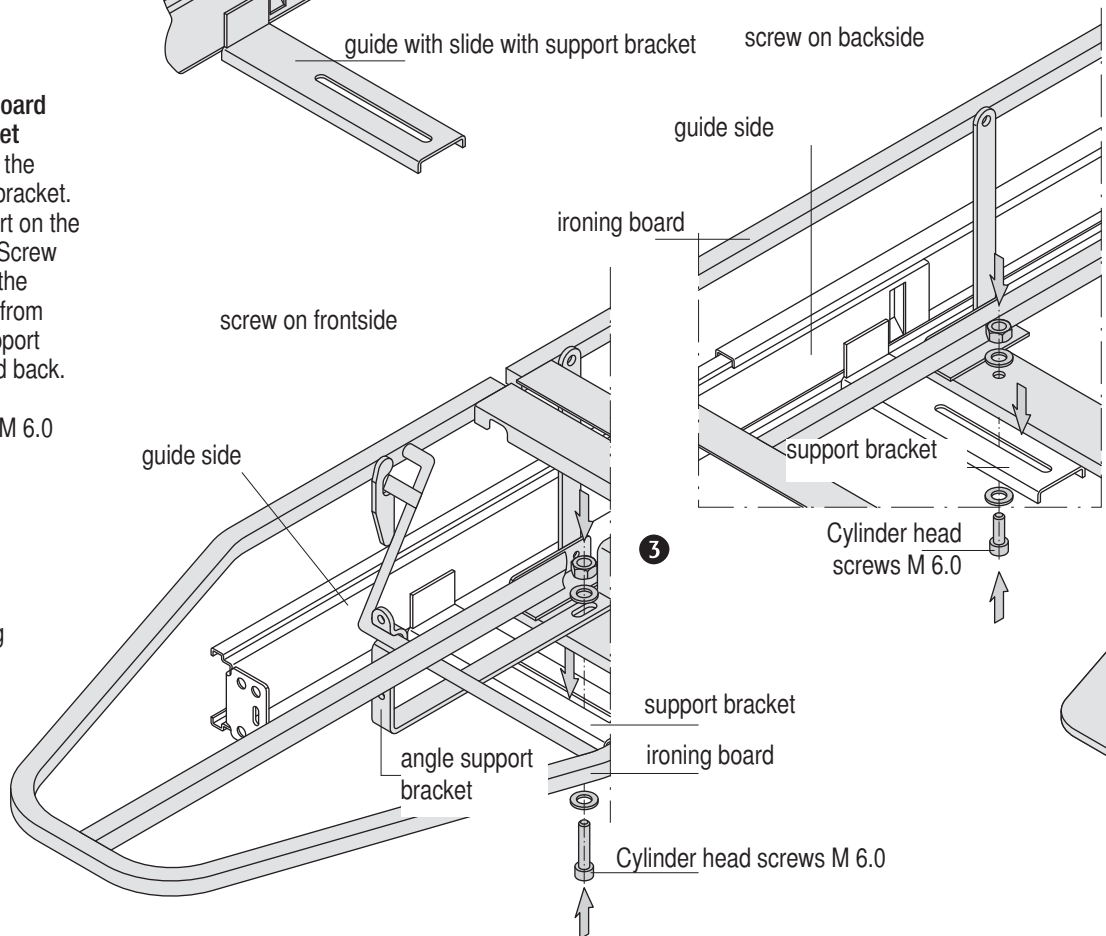
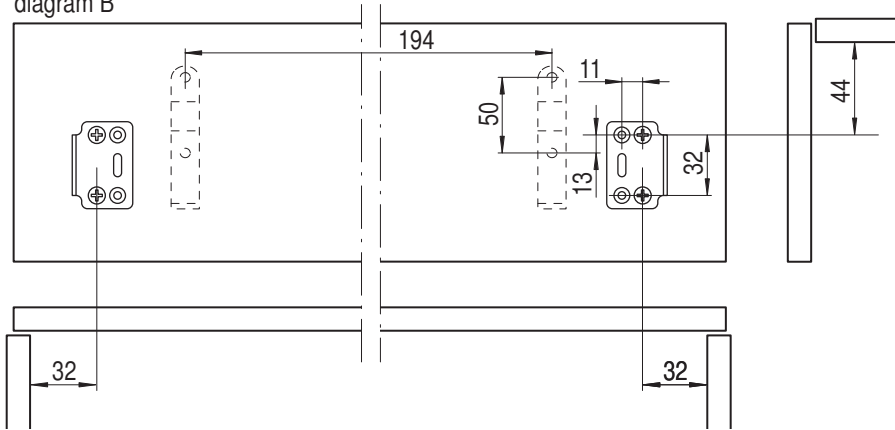

diagram B



4 Assembling "frontis plate"
Attach the "frontis plate" as indicated in diagram B.

Fasteners:
countersunk screws 4.5 x 15
or Euro-screws 6.3 x 13

5 Assembling angle support
bracket with the board to
the frontis plate:

screw the angle support
bracket onto the frontis plate.
Fasteners:
panhead screws 4.0 x 16

